

UNIVERSAL JOINT

GROVE

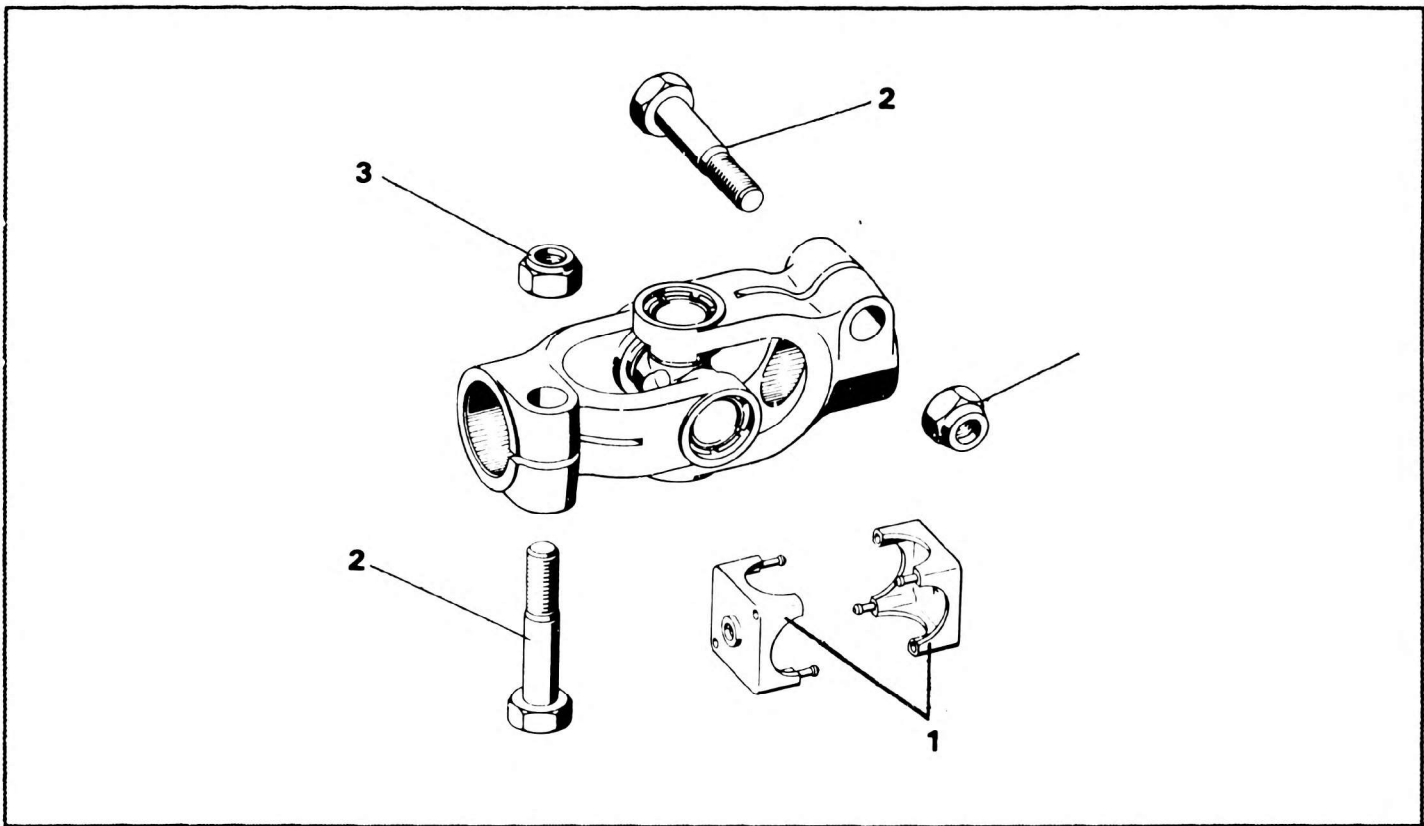

NO.	PART NO.	QTY	DESCRIPTION	NO.	PART NO.	QTY	DESCRIPTION
	7-364-001584		COMPLETE ASSY				
1	9-364-100715	2	CAP				
2	7-099-000566	2	PLATE				
3	9-810-100092	2	NUT				